

ANECHOIC

PREMIUM TITANIUM SUPPRESSORS

ANECHOX30L

MANUAL

OVERVIEW

TECHNICAL SPECIFICATIONS

ANECHOX30L

Best-in-Class Multi-Caliber Titanium Suppressor featuring our X-Baffle Anechoic™ Chamber System for all firearms up to 30 caliber, even 300 Ultra and 30-378 Wby Mag. Excellent on smaller calibers like 223/5.56mm. Best choice for subsonic to magnum rifles in 6mm, 25 cal, 6.5mm, 270, 7mm, 30 cal.

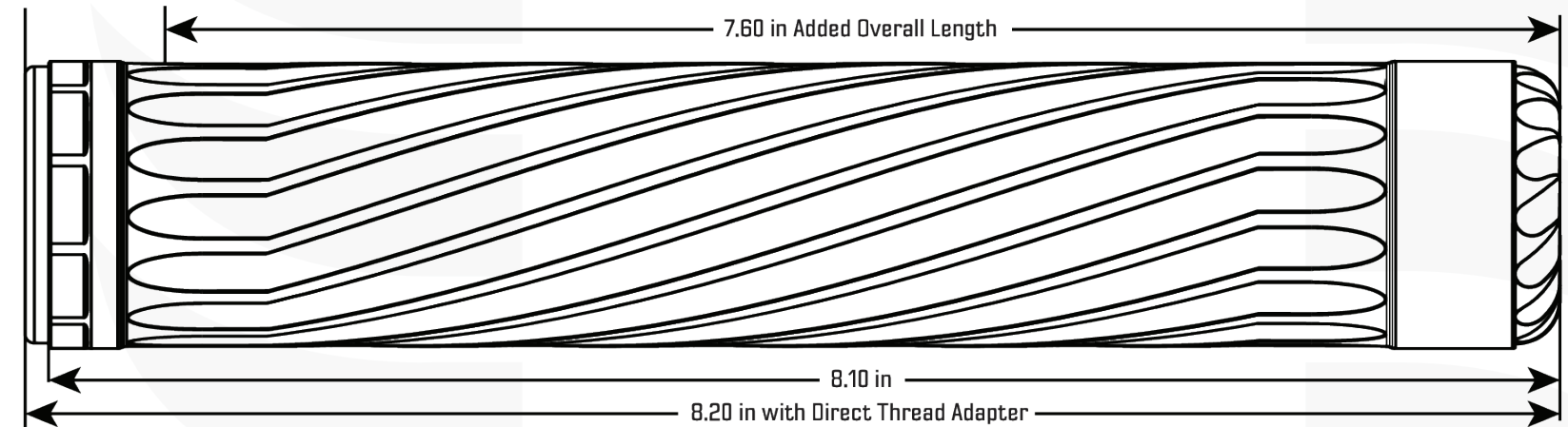

AnechoX 30 CRUSHES sound and recoil! The ultimate multi-caliber suppressor. Designed for incredible sound, recoil, and muzzle flash performance on a 7.62/.308 or the most powerful 30 caliber magnum. Phenomenal results on rifles from .17 Hornet through 7mm. The AnechoX 30 is simply the best, lightest, quietest, lowest recoil, disassemblable, user-serviceable 30 cal Titanium Suppressor ever made! Just 10.2 ounces plus adapter, and 8" X 1.62" diameter.

Shoot AR-10s and big 30 cal magnums with no hearing protection and have the quietest rifle on the range. Easily carry your hunting rifles all day and leave your hearing protection at home.

Ridiculously low recoil, even on ultra-light 300 magnums. Outperforms every can on the market in weight, sound, recoil, and serviceability.

All Anechoic AnechoX's are made of Titanium grade 5 STA 1000 (basically the highest alloy Titanium in its strongest heat-treat condition) with Stainless 17-4 H900 (ditto for stainless) blast chambers and blast baffles to handle the extreme erosion, highest uncorking pressure, and temperature right at your gun's muzzle.

All Anechoics use the revolutionary X-Baffle ACS™ shape with an interrupted central tube and are finished with Cerakote C Series high temperature thin film ceramic.

The Anechoic AnechoX's are the absolute state of the art and the pinnacle of performance for their weight, size, and serviceability.

The AnechoX 30 comes with a 5/8"-24 Direct Thread Adapter installed but accepts any of Anechoic AnechoX Direct Thread Adapters or any industry standard 1 3/8"-24 mount including Bravo, Hub, Pistons, Boosters, Nielsen Devices, QDs, Tri-lugs, and many more.

The AnechoX 30 is full-auto rated to 50 rounds 5.56/.223, 15 rounds 7.62/.308. Rapid-fire rated to 20 rounds 7.62/.308, 45-70 +P, or .450 Bushmaster, 8 rounds 300 Win Mag. Rifles are rated with standard rifle barrel lengths and round count must be reduced for shorter barrels. Do not exceed 800° F.

Maximum bullet diameter for the AnechoX 30 is .313".

MATERIALS	COATING	WEIGHT	LENGTH X DIAMETER	CALIBER	THREAD PITCH	FULL -AUTO RATING	SOUND REDUCTION	MAINTENANCE
Heat-Treated Grade 5 Titanium, Heat-Treated 17-4 Stainless Steel	Cerakote C Series high temperature thin film ceramic	10.2 ounces, 11.0 ounces with 5/8"-24 Titanium DTA included	8.1" X 1.62", 8.2" with Titan DTA included. Adds 7.6" installed	5.56/223, 240 Wby, 6mm ARC, 25-06, 6.5 Creed, 270, 7mm Mag, 7.62/308, 30-06, 300 Mag, 30-378 Wby	Accepts any 1-3/8" X 24 mount. 5/8"- 24 Titanium DTA included	50 rnds 5.56/223, 15 rnds 7.62/308. Rapid-fire: 20 rnds 7.62/308, 8 rnds 300 Mag. Do not exceed 800° F	Up to 42 dB	Completely End-User Serviceable. Wrenches Included

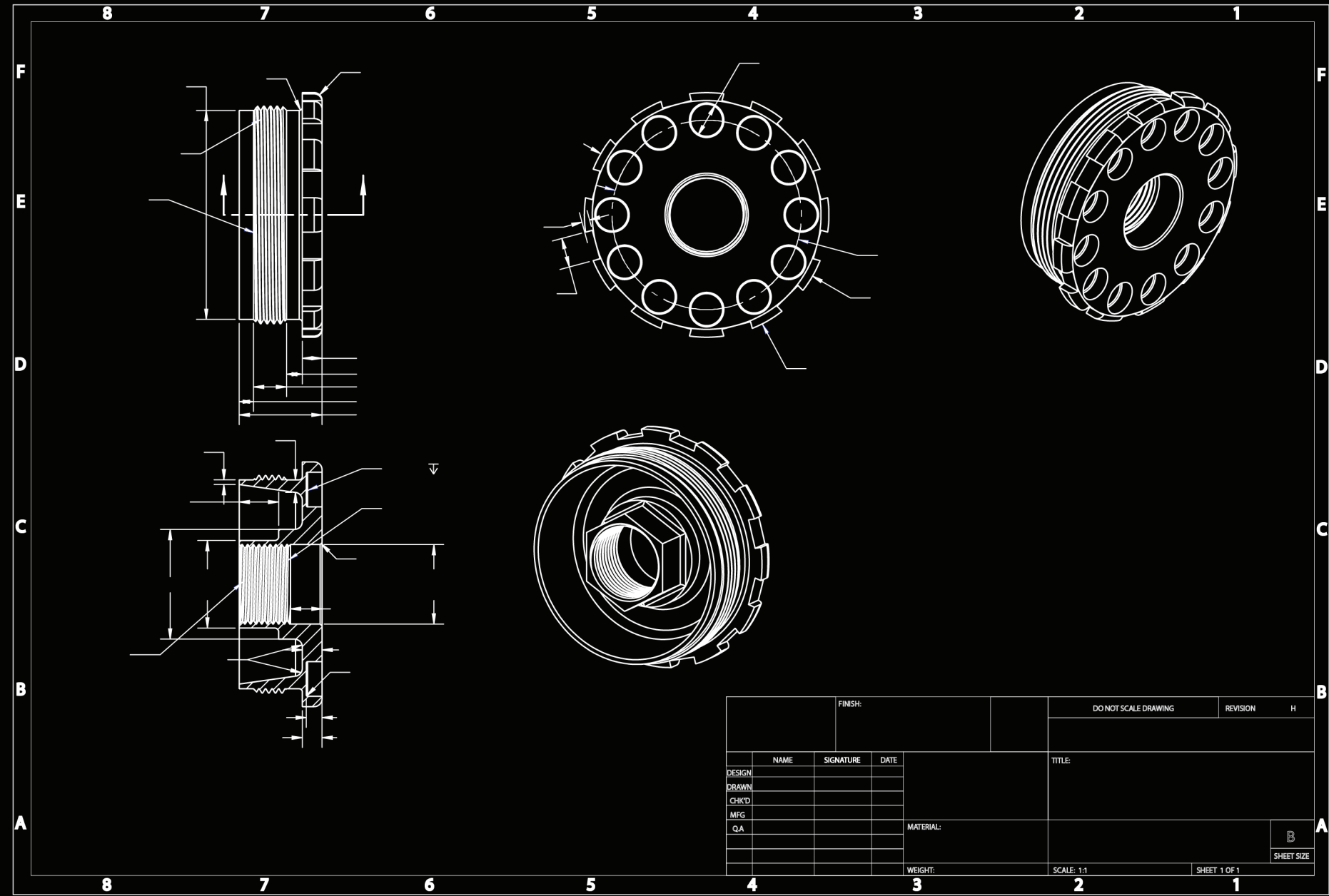

FINISH:			DO NOT SCALE DRAWING		REVISION	H
NAME			SIGNATURE		DATE	
DESIGN					TITLE:	
DRAWN						
CHK'D						
MFG						
QA						
			MATERIAL:			
			WEIGHT:		SCALE: 1:1	
					SHEET 1 OF 1	
					B SHEET SIZE	

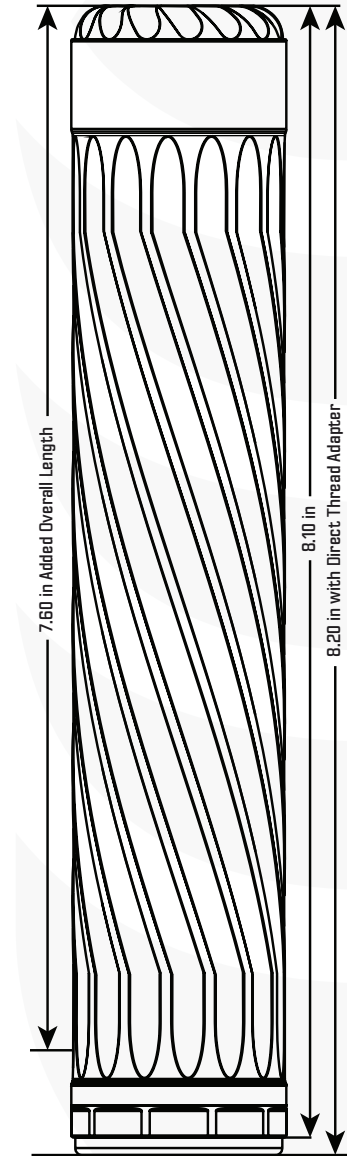

ANECHO X30L

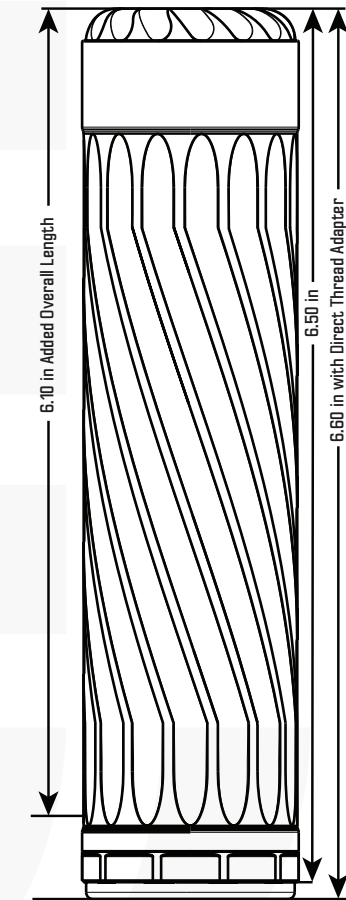

ANECHO X30



ULTRA-LIGHT



ACCURATE



WHISPER-QUIET



ADVANCED TECHNOLOGY



END-USER SERVICEABLE



SLEEK MODERN DESIGN

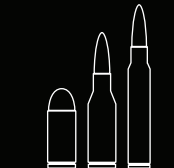

MULTI-CALIBER

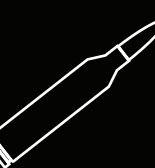

MAGNUM-RATED

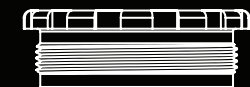

UNIVERSAL MOUNTING SYSTEM



TITANIUM

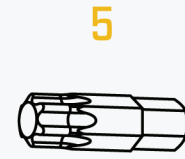
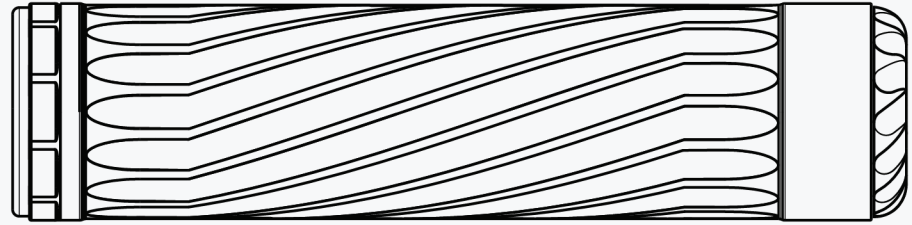

1

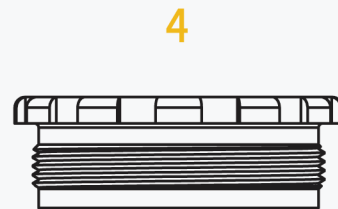
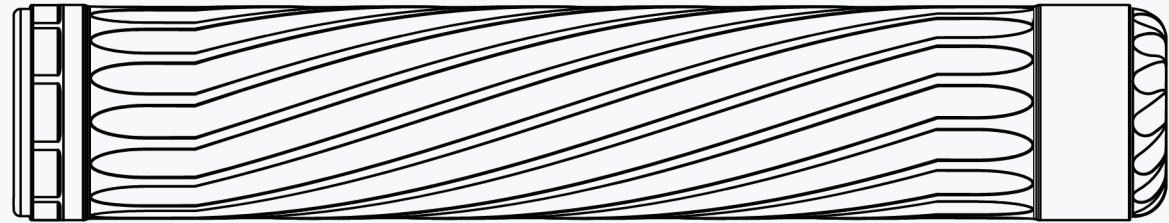

ANECHOX

WHAT'S INCLUDED

- 1 Suppressor
- 2 AnechoX Body Wrench
- 3 AnechoX DTA Spanner Wrench
- 4 Direct Thread Adapter
- 5 AnechoX Front Cap Torx Wrench

INSTALLATION STEPS

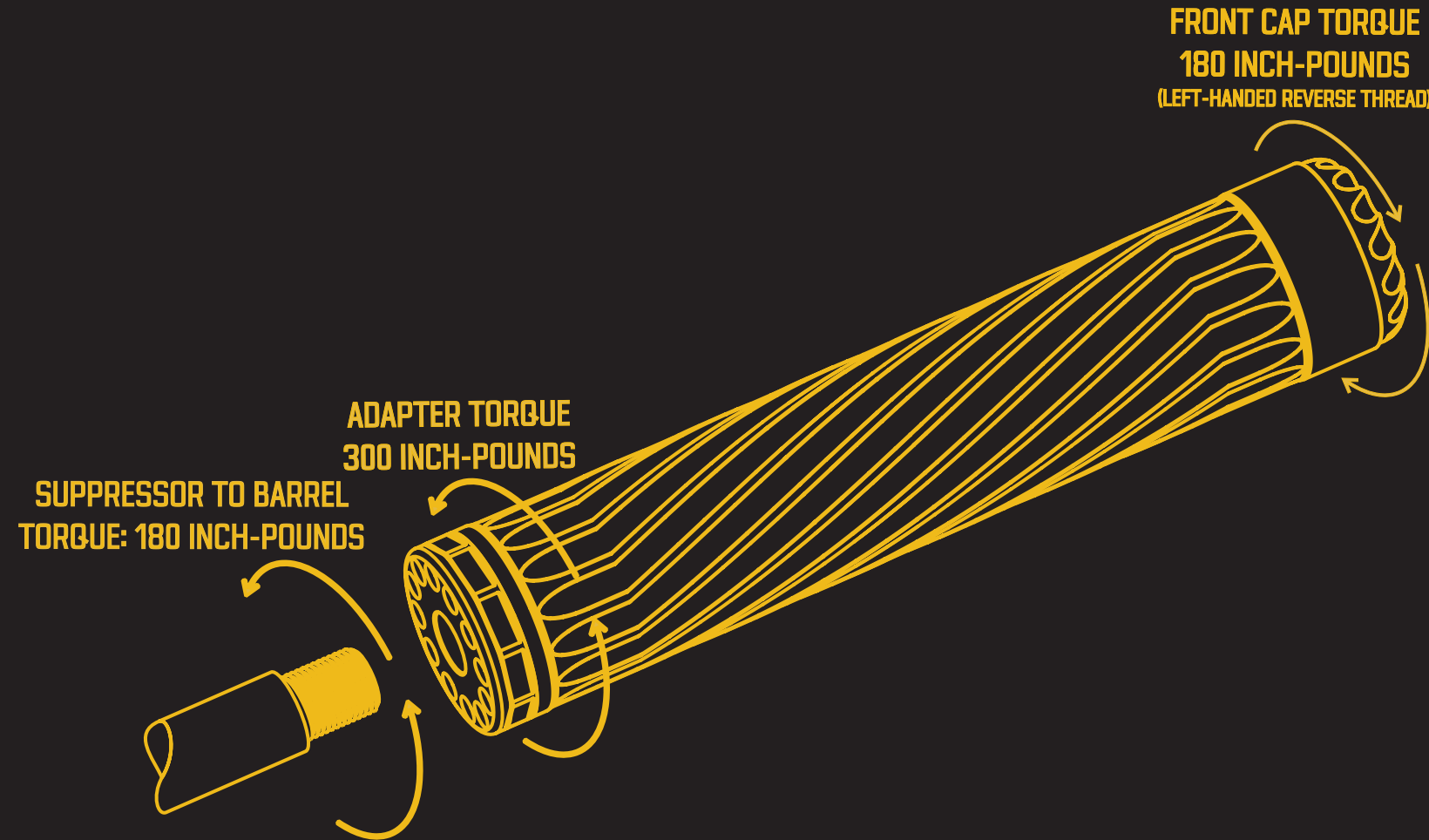

1) Torque Front Cap and rear Direct Thread Adapter to 20 ft-lbs, 25 ft-Lbs if shooting the most powerful magnum rifles. FRONT CAP IS A LEFT HANDED THREAD, SO TURN 'BACKWARDS' - LEFTY TIGHTY!!!

2) Align fully assembled silencer exactly straight with barrel, and screw on. 'Torque' to firearm using a strong hand, or 15 ft-lbs.

3) If shooting a gun more powerful than a .308 Win / 7.62 NATO, shoot ONE shot and re-torque everything.

4) For all firearms, shoot another 5 to 10 rounds and re-torque everything. Carefully check tightness frequently during use, especially with the most powerful rounds and especially the first time the silencer is fired, or the first time it is fired on a more powerful firearm.

WARNING: If you fire a silencer that has come loose, you can get a baffle strike which will ruin your silencer and could cause other damage, injury, or death. Your suppressor should be firmly tightened with a very strong hand, or wrench force. Use a wrench for removal. Use Kevlar BBQ gloves or other heat pads when handling a hot suppressor. Your Anechoic™ suppressor is so incredibly light that it will cool in just minutes, much faster than heavier silencers and can then be handled without gloves.

ASSEMBLY VIEW

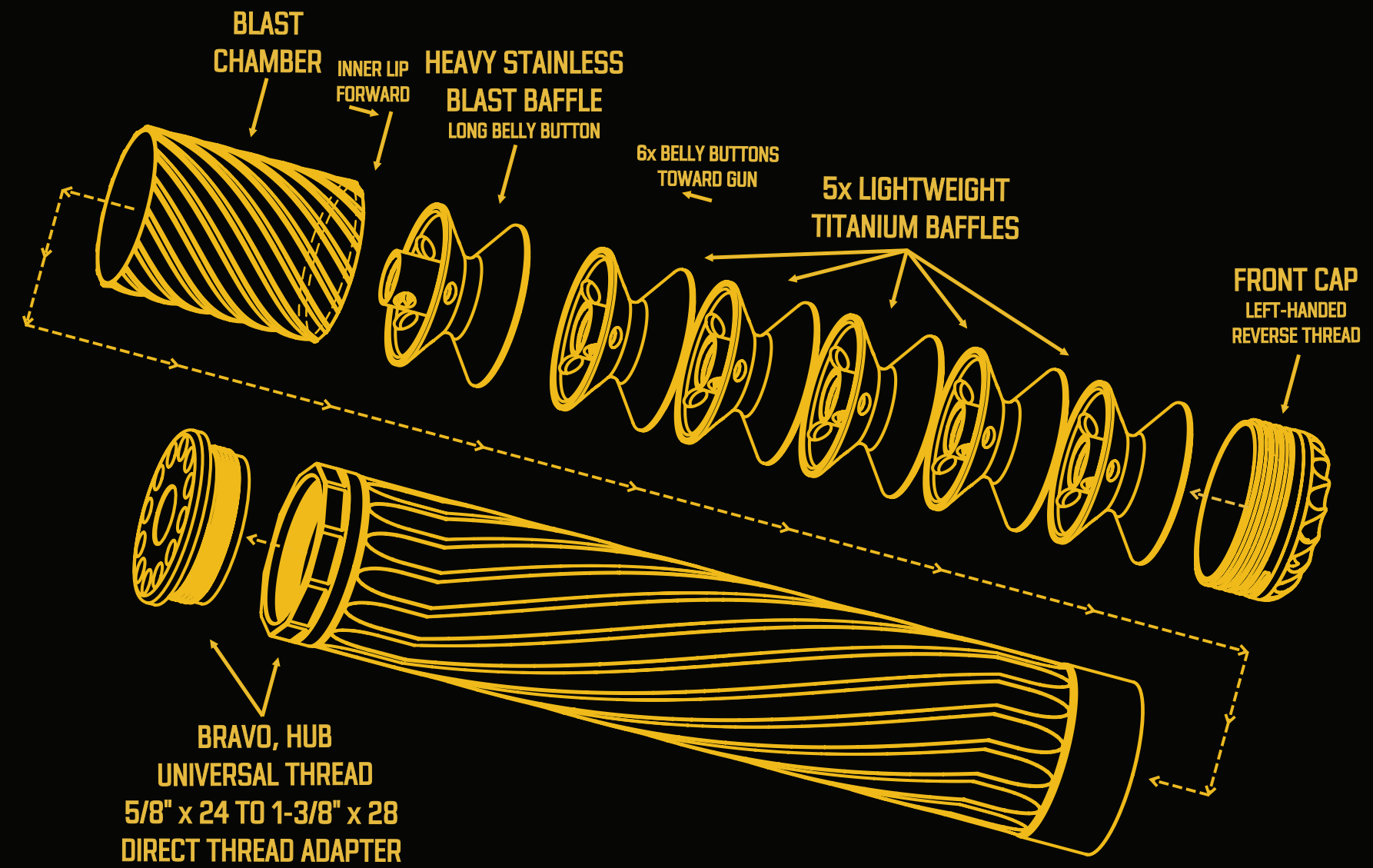
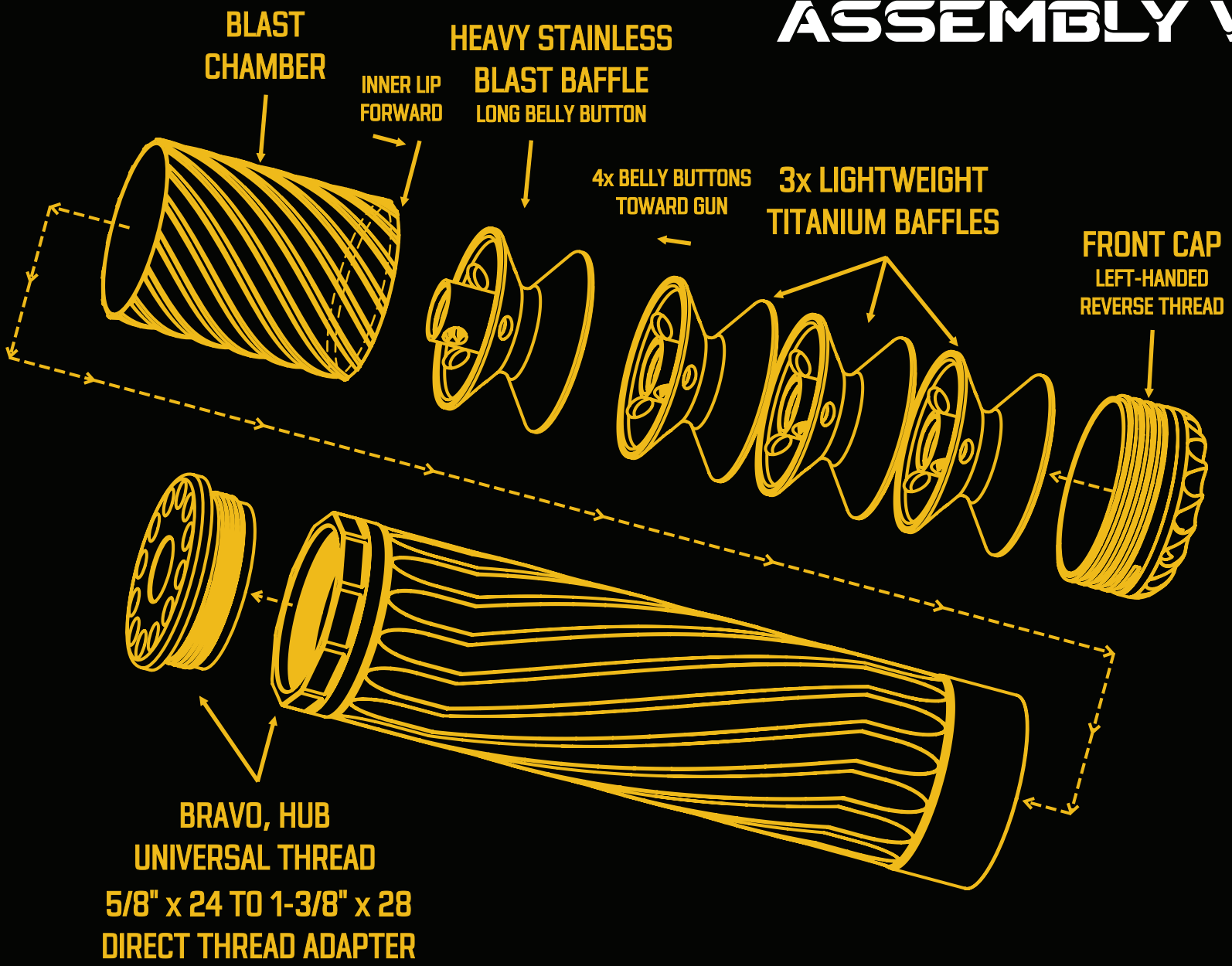



SHOOTING & PRO TIPS

1) Keep your silencer TIGHT! The most common 'death' of a silencer is a Baffle Strike because something wasn't tight or came loose. All three joints must be torqued/tightened before shooting your first shot, all three joints must be re-torqued after the first shot, and after 5-10 shots, and then periodically through your first trip to the range. (Front Cap, Mount or Adapter, Mount to Firearm). This is particularly important for more powerful firearms.

2) Don't mount a silencer on a firearm of a larger caliber. Seems obvious, but, 35 caliber bullets don't fit through 30 caliber holes, etc.

3) Don't mount a silencer on a firearm with questionable muzzle threads. Cheap, old, or foreign firearms may have threads that are aligned well enough for a flash hider, but are not sufficiently aligned with the bore to trust with your silencer. If in doubt, your gunsmith can check the alignment BEFORE you take the first shot.

4) Clean your muzzle threads and silencer threads before attaching your silencer to your firearm. Usually this means wiping off all dust and fibers with a cloth.

5) Don't shoot a damaged silencer, or one that you suspect may have had a Baffle Strike - even one shot. Stop immediately, unload the firearm and make it safe, remove the silencer from the firearm, and thoroughly inspect the silencer.

6) Don't loan your silencer to a friend or relative who is not the owner. That would be an illegal transfer of an NFA item and is a federal felony.

7) Don't take your silencer across state lines without ATF approval, and checking the laws of all states involved. Ditto for foreign hunts.

WARNING

WARNING

Use proper safety equipment when handling. Make sure firearm is completely safe and unloaded with no rounds chambered when attaching and detaching a suppressor.

Frequently verify the suppressor is securely torqued onto the barrel, especially the first few times you shoot it. Use caution when handling shortly after use. Silencers become very hot when shooting many rounds of powerful ammo, so avoid contact with skin and synthetic materials. Use heat resistant gloves or allow time for cooling.

Use with the correct serviceable firearm and correct ammunition. Discharging firearms in poorly ventilated areas, cleaning firearms or handling ammunition may result in exposure to lead and other substances, which can cause birth defects, reproductive harm and other serious physical injury. Ensure adequate ventilation at all times. Wash hands thoroughly after exposure.

LEGAL WARNING

Suppressors are controlled under Federal and some State and Local laws. The owner of the silencer or other legally authorized person **MUST** be present when it is transported, used, or possessed. It must be stored and locked up according to regulations.

Check your Federal, State, and Local laws concerning the legality of owning, possessing, hunting, and transporting any silencer. Don't even think about taking a silencer to or through CA, HI, IL, NJ, NY, DC, DE, RI, MA (as of Dec 1, 2023).

WARRANTY

All ANECHOIC AnechoX's have a Limited Lifetime Warranty against all manufacturing defects and damage to this product caused by normal use of this product. ANECHOIC™ will repair or replace any suppressor we make, free of charge or at no more than 50% or replacement price. This warranty does not cover damage to our products or host firearm, resulting from careless or irresponsible handling. ANECHOIC™ assumes no liability for unsafe or illegal use of the silencer by its purchaser or any other user who comes into contact with the product after purchase. ANECHOIC™ does not cover damage to the silencer or host firearm resulting from improperly hand loaded, reloaded, previously used or otherwise defective ammunition. This warranty extends to any and all parts as originally sold by us, but does not extend to any altered product after the original purchase, damaged through abuse, misuse through lack of proper care and maintenance, or used other than for its legally intended purposes. The product is sold "as is" with no further implied contractual rights or warranties beyond those expressly stated herein.



Proud Member of the American Suppressor Association.

Designed and manufactured in the USA by proud, free, brilliant, beautiful people like you.

Register your ANECHOIC product online to activate your Lifetime Warranty at: ASILENCER.COM/REGISTER



ANECHOIC

PREMIUM TITANIUM SUPPRESSORS